

RALLY MIG 161i

RESERVEDELSLISTE
SPARE PARTS LIST
ERSATZTEILLISTE
LISTE DES PIÈCES DE RECHANGE



MICATRONIC
WELDING VALUE





RALLYMIG 161i

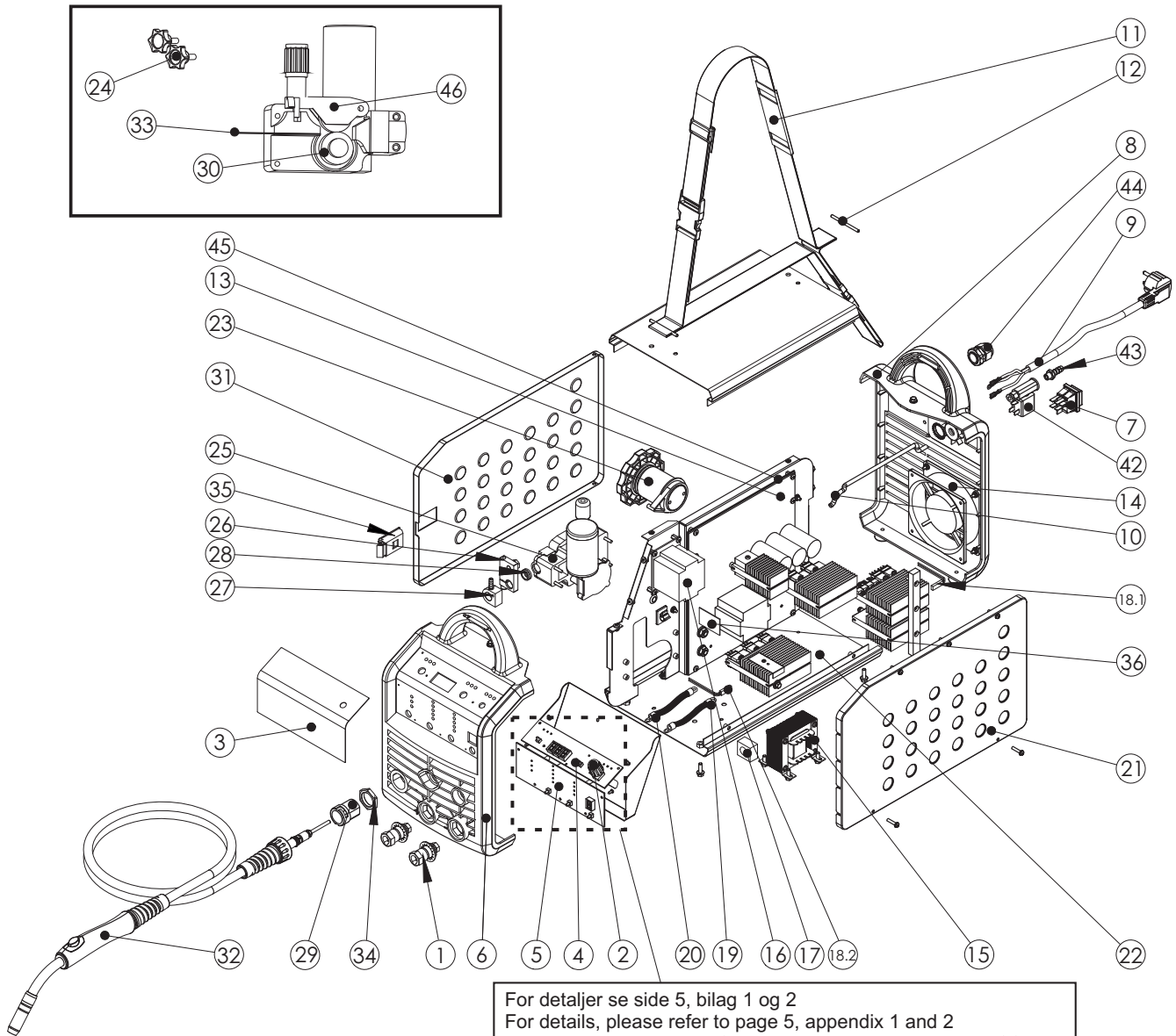

Pos.	No.	Varebetegnelse Warenbezeichnung	Description of goods Désignation des pièces
1	82046200	Dinsebøsning Dinsebuchse	Dinse coupling socket Douille de raccordement, type Dinse
2	82046201	Knap og Dæksel for knap Knopf und Deckel für den Knopf	Button and cover for button Boeton et couvercle de bouton
3	82046202	Folie Folie	Foil Feuille
4.1	71613904	Display print, MK2 (gældende fra serienr. 1307xxxx) Display Platine, MK2 (gültig ab Seriennr. 1307xxxx)	Display PCB, MK2 (valid from serial no. 1307xxxx) Carte de circuit imprimé de display, MK2 (valable à partir du numéro de série 1307xxxx)
4.2	71613901	Display print, MK1 (gældende fra serienr. 1208xxxx til 1306xxxx) Display Platine, MK1 (gültig ab Seriennr. 1208xxxx bis 1306xxxx)	Display PCB, MK1 (valid from serial no. 1208xxxx to 1306xxxx) Carte de circuit imprimé de display, MK1 (valable à partir du numéro de série 1208xxxx à 1306xxxx)
5.1	71613903	CPU print, MK2 (gældende fra serienr. 1307xxxx) CPU Platine, MK2 (gültig ab Seriennr. 1307xxxx)	CPU control PCB, MK2 (valid from serial no. 1307xxxx) Carte de circuit imprimé de CPU, MK2 (valable à partir du numéro de série 1307xxxx)
5.2	71613902	CPU print, MK1 (gældende fra serienr. 1208xxxx til 1306xxxx) CPU Platine, MK1 (gültig ab Seriennr. 1208xxxx bis 1306xxxx)	CPU control PCB, MK1 (valid from serial no. 1208xxxx to 1306xxxx) Carte de circuit imprimé de CPU, MK1 (valable à partir du numéro de série 1208xxxx à 1306xxxx)
6	82046203	Plastikfront Plastikfront	Plastic front Façade plastique







RALLYMIG 161i

Pos.	No.	Varebetegnelse Warenbezeichnung	Description of goods Désignation des pièces
7	82046204	Afbryder, vandtæt Schalter, wasserdicht	Switch, waterproof Interrupteur, étanche à l'eau
8	82046205	Plastikbag Plastickrückwand	Plastic back Façade postérieure plastique
9	82046206	Netkabel med schuko stik Netzkabel mit Schuko Stecker	Mains supply cable with schuko plug Câble d'alimentation avec prise schuko
10	82046207	Gasslange Gasschlauch	Gas hose Tuyau de gaz
11	82046208	Bærerem Tragriemen	Carrying strap Carrying strap
12	82046209	Remstrammer Riemenspanner	Carrying strap fastener Fixation pour sangle de transport
13.1	82046250	Invertermodul, MK2 (gældende fra serienr. 1307xxxx) Invertermodul, MK2 (gültig ab Seriennr. 1307xxxx)	Inverter module, MK2 (valid from serial no. 1307xxxx) Module onduleur, MK2 (valable à partir du numéro de série 1307xxxx)
13.2	82046210	Invertermodul, MK1 (gældende fra serienr. 1208xxxx til 1306xxxx) Invertermodul, MK1 (gültig ab Seriennr. 1208xxxx bis 1306xxxx)	Inverter module, MK1 (valid from serial no. 1208xxxx to 1306xxxx) Module onduleur, MK1 (valable à partir du numéro de série 1208xxxx à 1306xxxx)
14	82046211	Ventilator med ledningssæt Lüfter mit Leitungssatz	Fan with wire set Ventilateur avec jeu de câble
15	82046212	Drossel Drossel	Choke Inducteur
16.1	82046253	PFC spole m/skrueterminaler, MK2 (gældende fra serienr. 1307xxxx) PFC drossel, MK2 (gültig ab Seriennr. 1307xxxx)	PFC choke with screw terminals, MK2 (valid from serial no 1307xxxx) PFC inducteur, MK2 (valable à partir du numéro de série 1307xxxx)
16.2	82046213	PFC spole, MK1 (gældende fra serienr. 1208xxxx til 1306xxxx) PFC drossel, MK1 (gültig ab Seriennr. 1208xxxx bis 1306xxxx)	PFC choke, MK1 (valid from serial no 1208xxxx to 1306xxxx) PFC inducteur, MK1 (valable à partir du numéro de série 1208xxxx à 1306xxxx)
17	82046214	Strømsensor Stromsensor	Current sensor Detecteur de courant
18.1	82046241	Termosensor 85°C Thermofühler 85°C	Thermal sensor 85°C Sonde thermique 85°C
18.2	82046215	Termosensor 75°C Thermofühler 75°C	Thermal sensor 75°C Sonde thermique 75°C
19	82046216	Strømkabel, negativ Stromkabel, Negativ	Current cable, negative Câble de courant, négatif
20	82046217	Strømkabel, positiv Stromkabel, Positiv	Current cable, positive Câble de courant, positif
21	82046218	Sideskærm, højre Seitenschirm, rechts	Side panel, right Plaque latérale droit
22	82046219	Bund Boden	Bottom Plaque de base
23.1	82046251	Bremsestav med lås, MK2 (gældende fra serienr. 1307xxxx) Bremsenabe mit Verschluß, MK2 (gültig ab Seriennr. 1307xxxx)	Brake hub with lock, MK2 (valid from serial no. 1307xxxx) Moyeu de frein avec fermoir, MK2 (valable à partir du numéro de série 1307xxxx)
23.2	82046221	Bremsestav m/lås, MK1 (gældende fra serienr. 1208xxxx til 1306xxxx) Bremsenabe m/Verschluß, MK1 (gültig ab Seriennr. 1208xxxx bis 1306xxxx)	Brake hub with lock, MK1 (valid from serial no 1208xxxx to 1306xxxx) Moyeu de frein avec fermoir, MK1 (valable à partir du numéro de série 1208xxxx à 1306xxxx)
24	82046222	Fingerskrue f. polvendning Rändelschraube f. Umpolung	Milled knob f. reverse of polarity Vis moleté pour inverser la polarité
25	82046223	Trådfremføring komplet Drahtvorschubeinheit Komplet	Wire feed unit complete Dispositif de guidage de fil
26	82046224	Strømskinne Stromschiene	Power rail Plaque cuivre
27	82046225	Gastilslutning Gasanschluss	Gas connection Raccordement au gaz
28	82046226	Styrering for svejse­slange Stützring für Schweißschlauch	Support ring for welding torch Bague support pour tuyau de soudage
29	82046228	Kabelgennemføring Kabeldurchführung	Cable lead-in Traversée de câble
30.1	82046229	Trisse 0,6 V-Spor - 0,8 V-Spor Drahtrolle 0,6 V-Spuhr - 0,8 V-Spuhr	Wire drive roll 0.6 V-Groove - 0.8 V-Groove Galet 0,6 V-trace - 0,8 V-trace
30.2	82046230	Trisse 0,8 V-Spor - 1,0 V-Spor Drahtrolle 0,8 V-Spuhr - 1,0 V-Spuhr	Wire drive roll 0.8 V-Groove - 1.0 V-Groove Galet 0,8 V-trace - 1,0 V-trace
30.3	82046232	Trisse 0,8 U-Spor - 1,0 U-Spor Drahtrolle 0,8 U-Spuhr - 1,0 U-Spuhr	Wire drive roll 0.8 U-Groove - 1.0 U-Groove Galet 0,8 U-trace - 1,0 U-trace
31	82046231	Låge Tür	Door Portillon
32	80191180	ML 160 svejse­slange ML 160 Schweißschlauch	ML 160 hose ML 160 tuyau de soudage
33	80160152	Liner indløb (ALU-svejsning) Drahtführungsspirale (ALU-Schweißen)	Wire guide inlet (ALU-welding) Guide fil (soudage ALU)

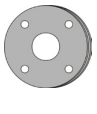
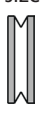

RALLYMIG 161i

Pos. No.	Varebetegnelse Warenbezeichnung	Description of goods Désignation des pièces
34	82046227 Møtrik, M27 Mutter, M27	Nut, M27 Ecrou, M27
35	82046233 Lås for låge Verschluß für Tür	Latch for door Fermoir, portillon
36	82046236 PWM print PWM Platine	PWM PCB Circuit imprimé PWM
37	82046234 Fladkabel 26pol Flachkabel 26 polig	Flat cable 26-pole Câble méplat, 26-pôles
38	82046235 Fladkabel 34pol Flachkabel 34 polig	Flat cable 34-pole Câble méplat, 34-pôles
39	82046237 SD-kortlæser (gældende fra serienr. 1208xxxx til 1306xxxx) SD-Kartenleser (gültig ab Serienr. 1208xxxx bis 1306xxxx)	SD card reader (valid from serial no. 1208xxxx to 1306xxxx) Lecteur carte SD (Valable à partir du numéro de série 1208xxxx à 1306xxxx)
40	82046240 Fladkabel 10pol (gældende fra serienr. 1208xxxx til 1306xxxx) Flachkabel 10 polig (gültig ab Serienr. 1208xxxx bis 1306xxxx)	Flat cable 10-pole (valid from serial no. 1208xxxx to 1306xxxx) Câble méplat, 10-pôles (Valable à partir du numéro de série 1208xxxx à 1306xxxx)
41	78861297 Servicekit - SW opgradering Servicekit - Softwareaufgradieren	Servicekit - software upgrade Servicekit - mise à jour logicielle
42	82046242 Gasventil Gasventil	Gas valve Valve de gaz
43	82046243 Gasstuds Gasstutzen	Gas connecting piece Raccord gaz
44	82046244 Kabelaflastning Kabeldurchführung	Cable relief Traverser de câble
45	82046252 Isoleringsplade for invertermodul Isolierplatte für Invertermodul	Insulating plate for inverter module Plaque d'isolation, module onduleur
46	82046255 Trådrullebom Drahtrollen-Druckarm	Wire coil pressure arm Bras presseur
81100137	Kit for ALU-svejsning Bausatz für Aluminiumschweißen	Kit for aluminium welding Kit pour soudage d'aluminium
82046220	Ledningskit for service (alle ledningssæt) Leitungskit für Service (alle Leitungssätze)	Wire kit for service (all wire harness sets) Kit fils service (filerie complète)

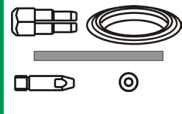
ML 161 i									
Wire	Inlet guide	Wire dia.	Wire roll	Wire roll size	Nipple torch	O-ring	Liner torch	Contact tip	Kit
	 Pos. 33	 Ø x x mm			 Pos. 15	 Pos. 19	 Pos. 9+10	 Pos. 3	
FE	Steel liner 80160153*	0.6 0.8 1.0	82046229 82046230 82046230	0.6-0.8 V 0.8-1.0 V 0.8-1.0 V	80100006 80100815* 80100815*	- - -	80160520 80160521* 80160521*	80130201 80130202* 80130203	
ALU/CuSi 3%	Plastic liner 80160152	1.0	82046232	0.8-1.0 U	80100006	-	80160560	80130103	81100137
FCW Innershield	Steel liner 80160153*	0.9	82046230	0.8-1.0 V	80100815*	-	80160521*	80130103	
Pos. = Machine spare parts list					Pos. = Torch spare parts list				

* Standard equipment



MIGATRONIC

54110207 C

RALLYMIG 161i

Valid from serial number 1307xxxx

Bilag 1
Appendix 1
Anhang 1

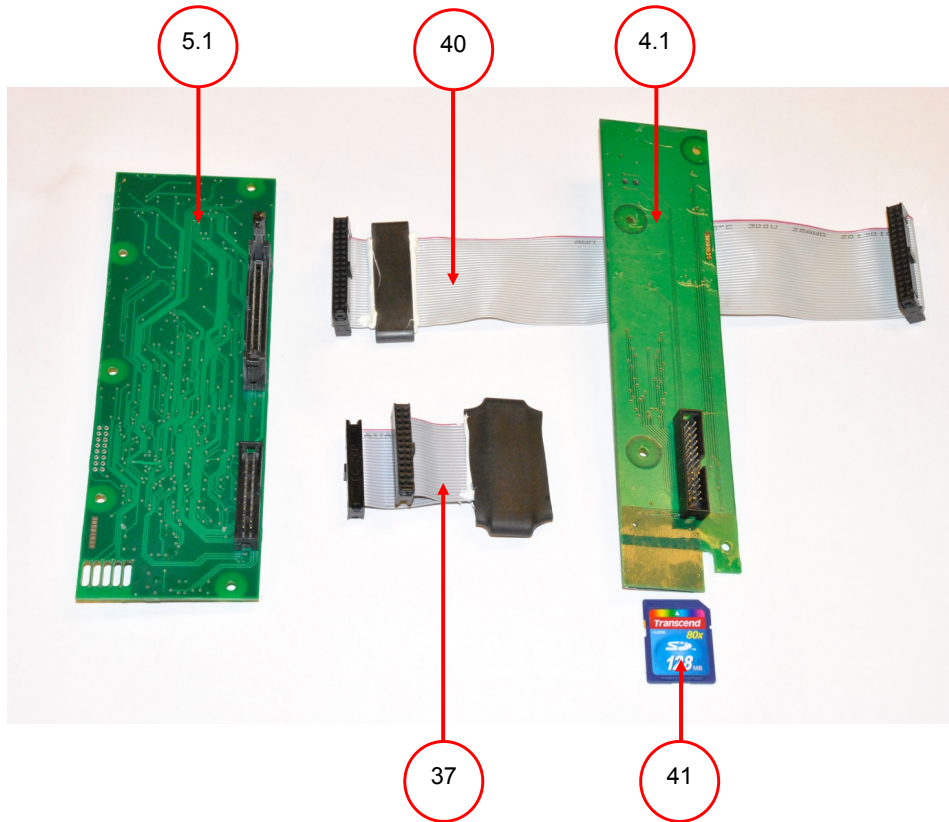

Valid from serial number 1208xxxx to 1306xxxx

Bilag 2
Appendix 2
Anhang 2

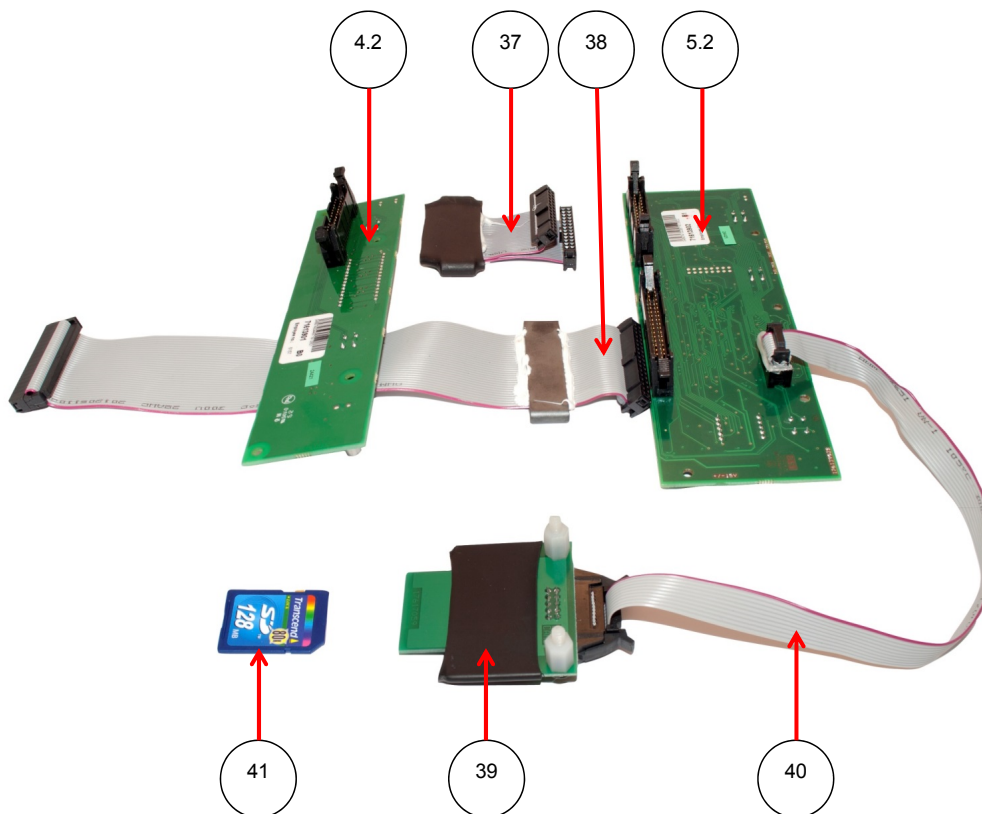



RALLYMIG 161i

Valid from serial number 1307xxxx

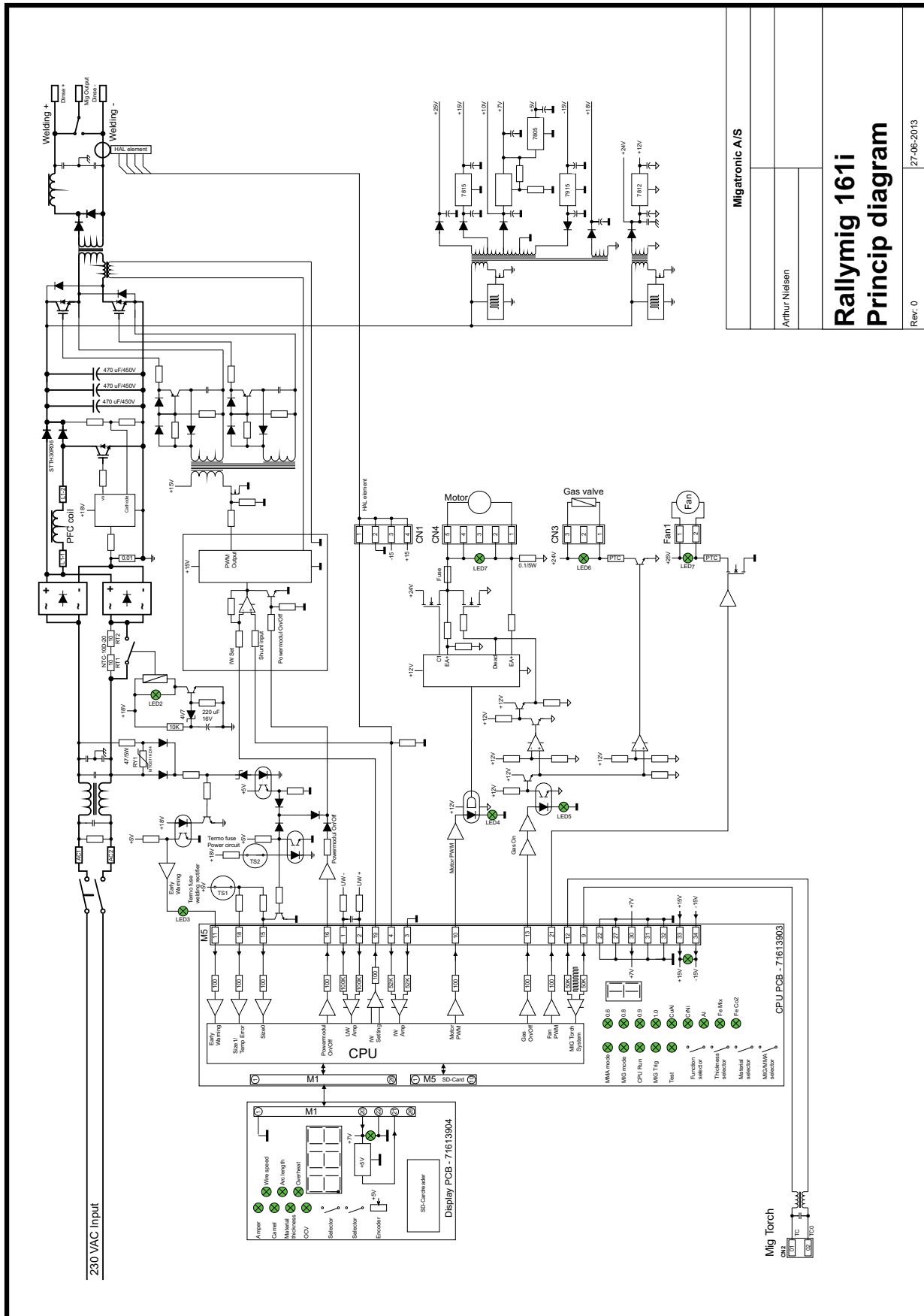

Migatronic A/S
Arthur Nielsen
Rallymig 161i
Princip diagram
Rev: 0
27-06-2013

RALLYMIG 161i

Valid from serial number 1208xxxx to 1306xxxx

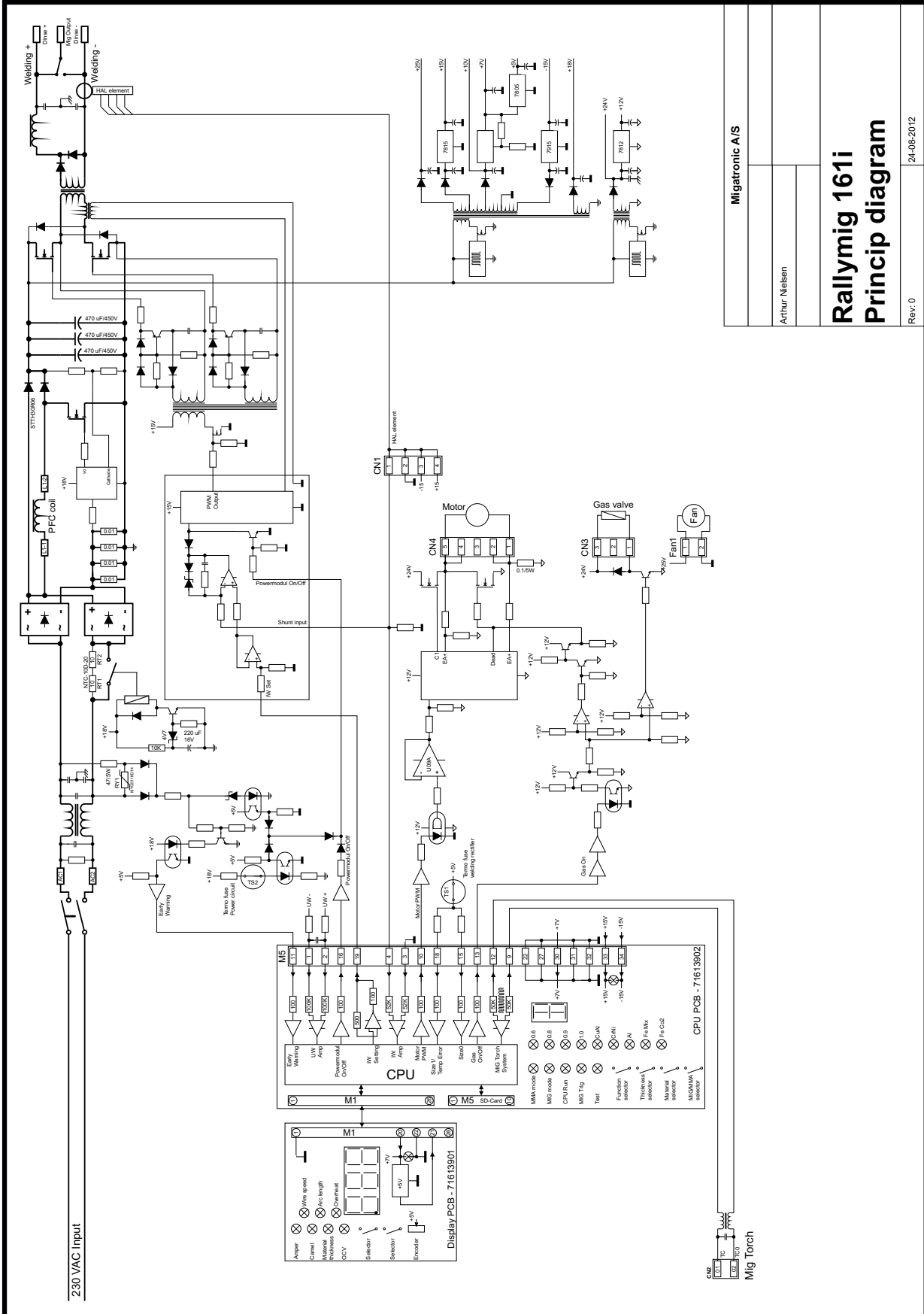

Migatronic A/S
Arthur Nielsen
Rallymig 161i Principle diagram
Rev: 0
24-08-2012



DENMARK:

Main office:

SVEJSEMASKINEFABRIKKEN MIGATRONIC A/S
Aggersundvej 33, 9690 Fjerritslev
Tel. 96 500 600, www.migatronicon.com

MIGATRONIC AUTOMATION A/S

Knøsgårdvej 112, 9440 Aabybro
Tel. 96 962 700, www.migatronicon-automation.dk

MIGATRONIC EUROPE:

England

MIGATRONIC WELDING EQUIPMENT LTD.
21 Jubilee Drive, Belton Park, Loughborough
Leicestershire LE11 5XS, England
Tel. (+44) 01509 267499, www.migatronicon.co.uk

France

MIGATRONIC EQUIPEMENT DE SOUDURE S.A.R.L.
Parc Avenir II, 313 Rue Marcel Merieux
69530 Brignais, France
Tel. (+33) 04 78 50 65 11, www.migatronicon.fr

Italia

MIGATRONIC s.r.l. IMPIANTI PER SALDATURA
Via Dei Quadri 40, 20871 Vimercate (MB), Italia
Tel. (+39) 039 9278093, www.migatronicon.it

Norway

MIGATRONIC NORGE AS
Industriveien 1, 3300 Hokksund, Norway
Tel. (+47) 32 25 69 00, www.migatronicon.no

Czech Republic

MIGATRONIC CZ a.s.
Tolstého 451, 415 03 Teplice 3, Czech Republic
Tel. (+42) 0417 570 660, www.migatronicon.cz

Hungary

MIGATRONIC KERESKEDELMI KFT.
Szent Miklós u. 17/a, 6000 Kecskemét, Hungary
Tel./fax:+36/76/505-969;481-412;493-243,
www.migatronicon.hu

Finland

MIGATRONIC OY
Koulutie 13 As. 6,25130 Muurla, Finland
Tel. (+358) 0102 176 500, www.migatronicon.fi

The Netherlands

MIGATRONIC NEDERLAND B.V.
Hallenweg 34, 5683 CT Best, Holland
Tel. (+31) 499 375 000, www.migatronicon.nl

Sweden

MIGATRONIC SVETSMASKINER AB
Nääs Fabriker, Box 5015,44 850 Tollerod, Sweden
Tel. (+46) 031 44 00 45, www.migatronicon.se

Germany

MIGATRONIC SCHWEISSMASCHINEN GMBH
Sandusweg 12, 35435 Wetztenberg, Germany
Tel. (+49) 641 982840, www.migatronicon.de

MIGATRONIC ASIA:

China

**SUZHOU MIGATRONIC WELDING
TECHNOLOGY CO. LTD.**
#4 FengHe Road, Industrial Park, SuZhou, China
Tel.. 0512-87179800, www.migatronicon.cn

India

MIGATRONIC INDIA PRIVATE LTD.
No.22 & 39/20H Sowri Street, Alandur
600 016 Chennai, India
Tel. (+91) 223 00074 www.migatronicon.com



MIGATRONIC
WELDING VALUE